

PRODUCT SPECIFICATION

4.3" RGB IPS LCD Module with SPI Interface

DT043CTFT-IPS, DT043CTFT-IPS-PTS, DT043CTFT-IPS-TS



Revision 1.1
30 May 2023

Displaytech, a SEACOMP company

Phone: 1.760.918.6722

sales@seacomp.com

www.seacomp.com

Contents of this document are subject to change without notice. No part of this document may be reproduced or transmitted in any form or by any means, electronic or physical, for any purpose, without the express written permission of Displaytech.

REVISION HISTORY

REV	CHANGE DESCRIPTION	DATE	APPR
1.0	Initial release	1 FEB 2021	N/A
1.1	Format update, combined specifications for DT043CTFT-IPS, DT043CTFT-IPS-PTS, DT043CTFT-IPS-TS.	17 JUL 2023	KK

Table of Contents

1 Overview	1
1.1 Applications	1
1.2 Features	1
1.3 Acronyms	1
2 Pin Descriptions	2
2.1 Scan Direction	3
3 Absolute Maximum Ratings	3
4 Electrical Characteristics	3
4.1 LED Backlight, Internal Circuit Diagram	4
5 Timing Characteristics, RGB Interface	5
6 Optical Characteristics	7
6.1 Figures	8
7 Environmental/Reliability Testing	9
7.1 Inspection Criteria	9
8 Precautions for Use of LCD Modules	10
8.1 Safety	10
8.2 Handling	10
8.3 Static electricity	10
8.4 Storage	10
8.5 Cleaning	10
8.6 Cautions for installation and assembly	10
9 Mechanical Drawings	11
9.1 DT043CTFT-IPS	11
9.2 DT043CTFT-IPS-PTS	12
8.3 DT043CTFT-IPS-TS	13

1 Overview

The Displaytech **DT043CTFT-IPS** is a 4.3" color display, composed of an IPS LCD panel, LCD driver, FPC cable with RGB interface, and LED backlight. The display area has a RGB pixel resolution of 480 x 272 pixels. Additionally, this series includes the **DT043CTFT-IPS-PTS** with capacitive touch panel and driver, as well as the **DT043CTFT-IPS-TS** with resistive touch panel.

1.1 Applications

- Mobile Navigation Systems
- Video Systems

1.2 Features

- Size 4.3 Inches
- Resolution 480 (RGB) x 272 Pixels
- Type IPS, Transmissive, Normally black
- Interfaces
 - LCD/Communication RGB/SPI
 - Capacitive Touch I²C¹
 - Resistive Touch 4-Wire Analog²
- Module Dimensions
 - DT043CTFT-IPS 105.50 mm (W) x 67.20 mm (L) x 2.95 mm (H)
 - DT043CTFT-IPS-PTS 105.50 mm (W) x 67.20 mm (L) x 4.70 mm (H)
 - DT043CTFT-IPS-TS 105.50 mm (W) x 67.20 mm (L) x 4.15 mm (H)
- Active Area 95.04 mm (W) x 53.86 mm (L)
- Pixel Pitch 0.198 mm (W) x 0.198 mm (L)
- Viewing Angle U/L/D/R 80/80/80/80
- Backlight Type LED, White
- Driver ICs
 - LCD SC7283
 - Capacitive Touch FT5446¹
- Weight 53 g

1.3 Acronyms

- FPC Flexible Printed Circuit
- I²C Inter-Integrated Circuit
- IPS In-Plane Switching
- LCD Liquid Crystal Display
- LED Light Emitting Diode
- RGB Red-Green-Blue
- SPI Serial-Peripheral Interface

¹ DT043CTFT-IPS-PTS option

² DT043CTFT-IPS-TS option

2 Pin Descriptions

LCD INTERFACE ³			
PIN	NAME	TYPE	DESCRIPTION
1 ~ 2	GND	PWR	Ground
3	VDD	PWR	Supply Voltage
4	$\overline{\text{RESET}}$	I	Display reset (active low)
5 ~ 12	R0-R7	I	Red data bus
13 ~ 20	G0-G7	I	Green data bus
21 ~ 28	B0-B7	I	Blue data bus
29	PCLK	I	Pixel clock
30	$\overline{\text{STBY}}$	I	Display Standby (active low)
31	HSYNC	I	Horizontal synchronous signal
32	VSYNC	I	Vertical synchronous signal
33	DE	I	Data enable (active high)
34	UD	I	Vertical scan direction control ⁴
35	LR	I	Horizontal scan direction control ⁴
36	$\overline{\text{CS}}$	I	Chip select (active low)
37	SCL	I	Serial clock
38	SDA	I/O	Serial data
39	NC	–	No connection
40	NC (XR)	O	X+, Resistive touch panel ⁵
41	NC (YD)	O	Y-, Resistive touch panel ⁵
42	NC (XL)	O	X-, Resistive touch panel ⁵
43	NC (YU)	O	Y+, Resistive touch panel ⁵
44	LED-K	PWR	LED backlight, cathode
45	LED-A	PWR	LED backlight, anode

CAPACITIVE TOUCH INTERFACE ⁶			
PIN	SYMBOL	TYPE	FUNCTION
1	SCL	I	I ² C clock
2	SDA	I/O	I ² C data
3	VDD	PWR	Supply Voltage
4	$\overline{\text{WAKE}}$	I	Reset/Wake (active low)
5	$\overline{\text{INT}}$	O	Interrupt (active low)
6	GND	PWR	Ground

³ Recommended mating connector: SEA8058-45 or equivalent

⁴ Refer to Scan Direction Configuration table

⁵ DT043CTFT-IPS-TS option (otherwise NC)

⁶ Recommended mating connector: FH12-6S-1SH(55) or equivalent

2.1 Scan Direction

SCAN DIRECTION CONFIGURATION			
U/D	L/R	HORIZONTAL SCAN DIRECTION	VERTICAL SCAN DIRECTION
0	1	Left to Right	Down to Up
0	0	Right to Left	Down to Up
1	1	Left to Right	Up to Down
1	0	Right to Left	Up to Down

3 Absolute Maximum Ratings⁷

ELECTRICAL				
PARAMETER		MIN	MAX	UNIT
Supply Voltage	V_{DD}	-0.3	3.6	V

ENVIRONMENTAL				
PARAMETER		MIN	MAX	UNIT
Operating Temperature	T_{OP}	-20	+70	°C
Storage Temperature	T_{ST}	-30	+80	°C

4 Electrical Characteristics⁸

POWER					
PARAMETER		MIN	TYP	MAX	UNIT
Supply Voltage	V_{DD}	3.0	3.3	3.6	V
Supply Current	I_{DD}	–	30	45	mA

LOGIC					
PARAMETER		MIN	MAX	UNIT	
Logic I/O Voltage	High	V_{IH}	$0.8 * V_{DD}$	V_{DD}	V
	Low	V_{IL}	0	$0.2 * V_{DD}$	V

LED BACKLIGHT					
PARAMETER		MIN	TYP	MAX	UNIT
Forward Current ⁹	I_F	–	40	60	mA
Forward Voltage	V_F	–	15	–	V
LED Lifetime ¹⁰	T_{LED}	–	50,000	–	Hr

⁷ Operation outside of the maximum ratings listed below may result in permanent damage to the display.

⁸ $V_{DD} = 3.3$ V, GND = 0 V, $T_A = 25$ °C

⁹ Backlight Power Consumption: 640 mW (typ.)

¹⁰ LED lifetime is defined as the amount of time it takes for brightness to decrease to 50% of its original value at $T_A = 25$ °C and $I_F = 40$ mA. LED lifetime may decrease if operating current, I_F , is higher than 40 mA.

4.1 LED Backlight, Internal Circuit Diagram

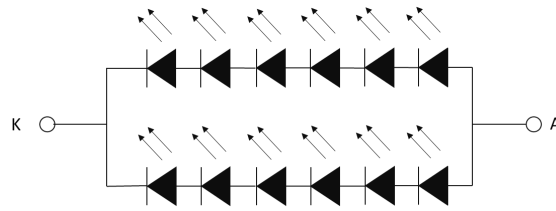

Figure 1 LED Backlight Circuit
2 x 6 = 12 LEDs, $I_F = 40 \text{ mA}$

5 Timing Characteristics, RGB Interface¹¹

The following are timing characteristics for 24-bit RGB input in SYNC-DE Mode. For additional options, refer to the SC7283 data sheet.

TIMING, PARALLEL 24-BIT RGB INPUT ¹²						
PARAMETER		MIN	TYP	MAX	UNIT	
DCLK Frequency	F_{CLK}	8	9	12	MHz	
DCLK Period	T_{CLK}	83	111	125	ns	
HSYNC	Period	T_H	485	531	598	DCLK
	Back porch ¹³	T_{HBP}	3	43	43	DCLK
	Display period	T_{HDISP}	–	480	–	DCLK
	Front porch	T_{HFP}	2	8	75	DCLK
	Pulse width	T_{HW}	2	4	43	DCLK
VSYNC	Period	T_V	276	292	321	HSYNC
	Back porch ¹²	T_{VBP}	2	12	12	HSYNC
	Display period	T_{VDISP}	–	272	–	HSYNC
	Front porch	T_{VFP}	2	8	37	HSYNC
	Pulse width	T_{VW}	2	4	12	HSYNC

¹¹ SYNC Mode requirement: $T_{VBP} = 12$ and $T_{HBP} = 43$ (not necessary in DE mode)

¹² $V_{DD} = 3.3$ V, $GND = 0$ V, $T_A = 25$ °C

¹³ Refer to SC7283 data sheet for Per H_BLANKING & V_BLANKING settings

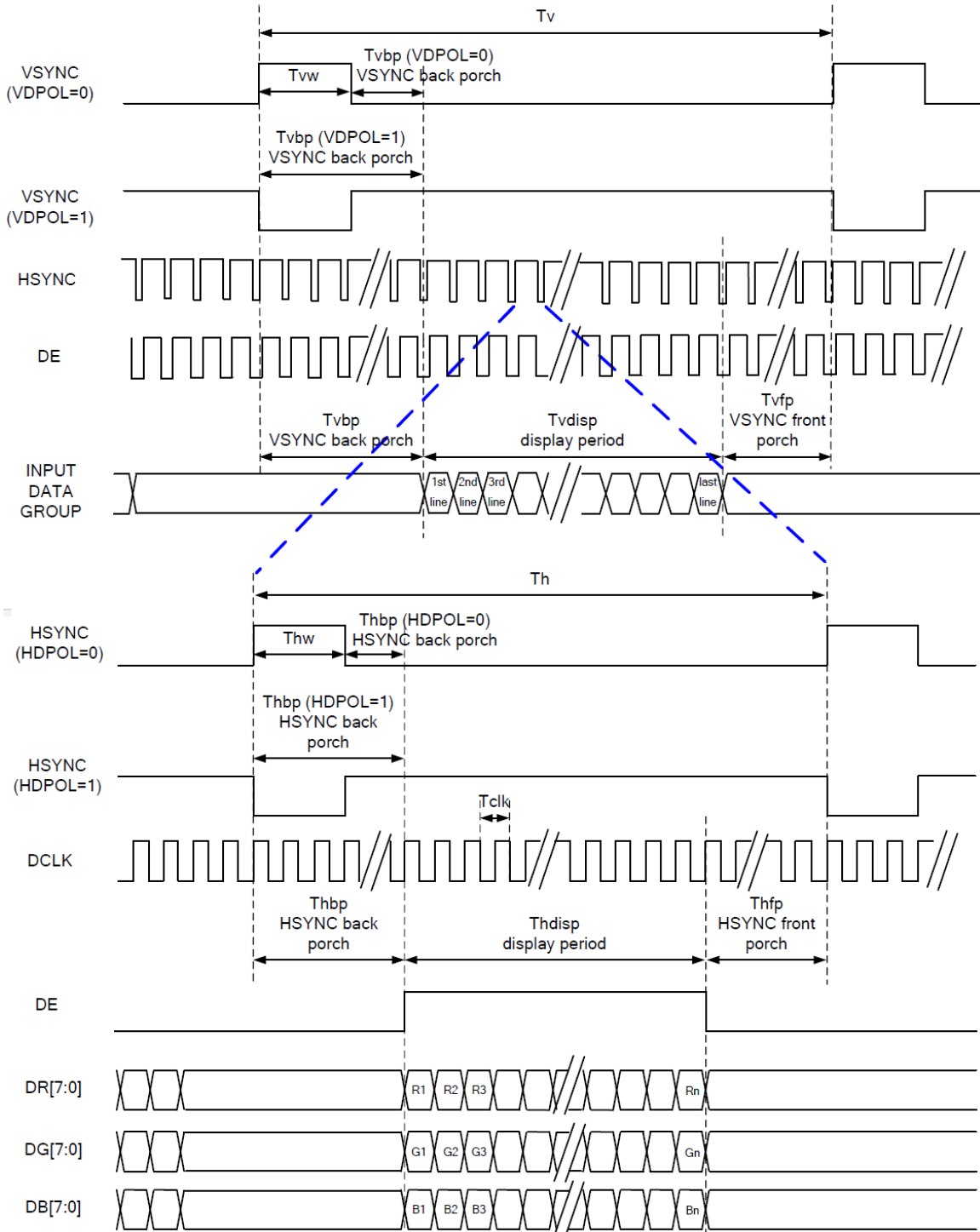

Figure 2 Timing, RGB Interface

6 Optical Characteristics

OPTICAL CHARACTERISTICS ¹⁴						
PARAMETER		MIN	TYP	MAX	UNIT	
Contrast Ratio ^{15,16}		CR	640	800	–	–
Response Time ¹⁷		T _{ON} / T _{OFF}	–	30	40	mS
View Angles ^{18,19}		ΘT	–	80	–	Degrees
		ΘB	–	80	–	
		ΘL	–	80	–	
		ΘR	–	80	–	
Chromaticity ²⁰		X _{RED}	Typ - 0.05	0.5943	Typ + 0.05	–
		Y _{RED}		0.3284		
		X _{GRN}		0.3879		
		Y _{GRN}		0.5561		
		X _{BLU}		0.1358		
		Y _{BLU}		0.0860		
		X _{WHT}		0.2965		
Y _{WHT}	0.2879					
NTSC		–	50	60	–	–
Luminance ¹⁶	DT043CTFT-IPS	L	400	550	–	cd/m ²
	DT043CTFT-IPS-PTS		340	480	–	
	DT043CTFT-IPS-TS		320	450	–	
Uniformity ¹⁶		U	80	–	–	%

¹⁴ See Section 6.1, Figure 3

¹⁵ Viewing Angle (Θ) = 0°

¹⁶ See Section 6.1, Figure 7

¹⁷ See Section 6.1, Figure 4

¹⁸ Contrast Ratio (CR) ≥ 10

¹⁹ See Section 6.1, Figure 5

²⁰ See Section 6.1, Figure 6

6.1 Figures

Figure 3: Optical Measurement System

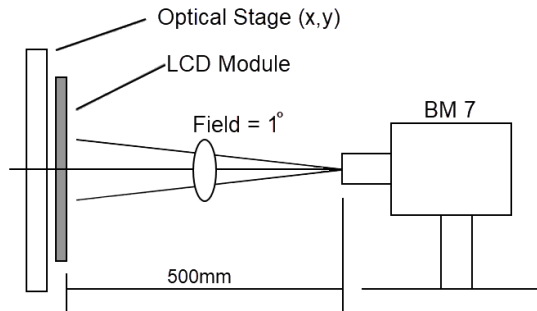

Conditions:

$I_F = 40 \text{ mA}$, $T_A = 25 \text{ }^\circ\text{C}$, ambient brightness $< 150 \text{ lx}$

Figure 4: Response Times

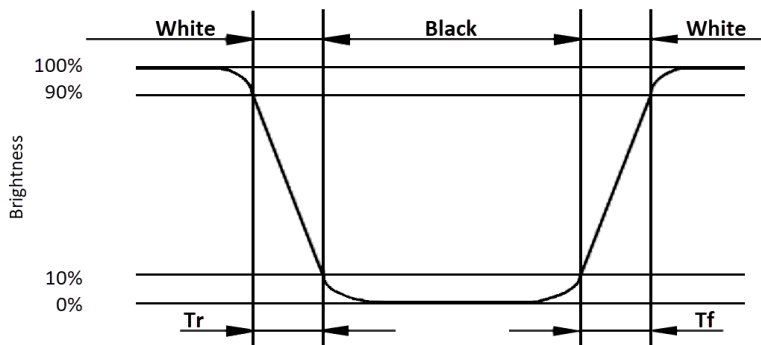

Decay Time (TF) = Time required for display to transition from white to black

Rise Time (TR) = Time required for display to transition from black to white

Figure 5: Viewing Angles

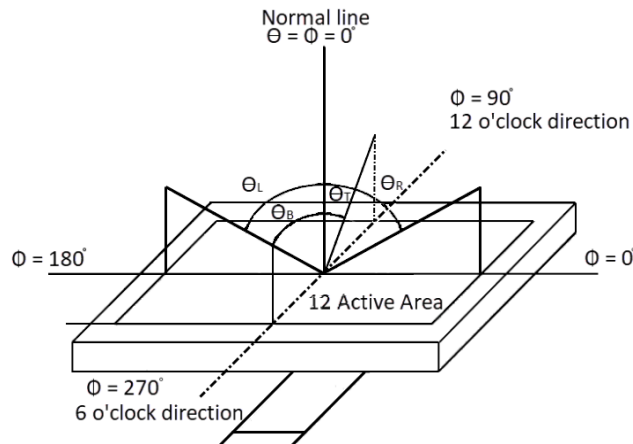

Viewing angle is measured from center point of LCD

Figure 6: Chromaticity (CIE 1931)

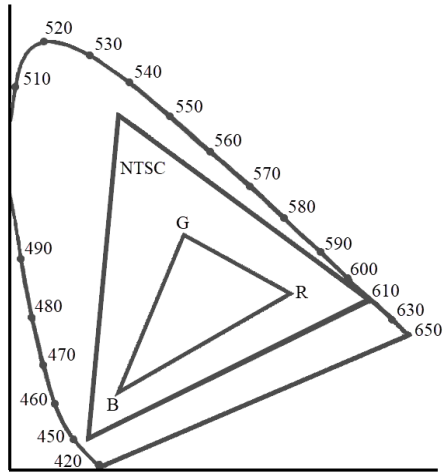

Chromaticity = Area of Δ_{RGB} / Area of Δ_{NTSC}

* Color coordinates measured at center point of LCD

Figure 7: Luminance Uniformity

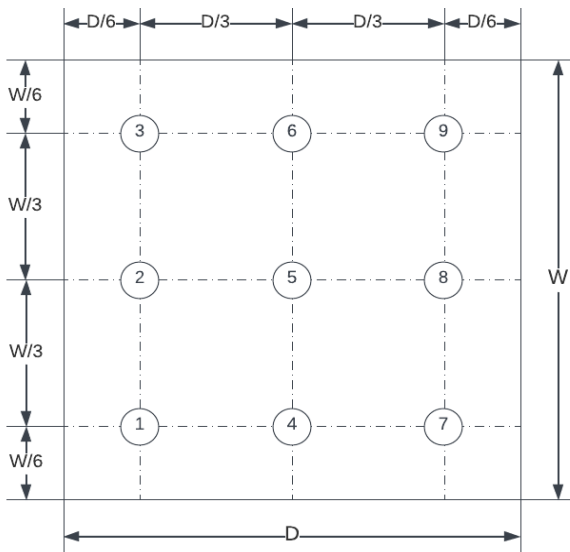

Luminance is defined as the brightness of all white pixels at the center of the display area at optimum contrast.

Uniformity is determined by measuring Luminance at 9 points and calculating $Luminance_{MIN} / Luminance_{MAX}$

Contrast Ratio = $\frac{Surface\ Luminance_{WhitePixels}}{Surface\ Luminance_{BlackPixels}}$

7 Environmental/Reliability Testing

Judgment is based on inspection performed after testing, per criteria described in the Inspection Criteria table.²¹

ITEM UNDER TEST	TEST CONDITION
High Temperature Operation	T _A = 70 °C, 96 Hrs
Low Temperature Operation	T _A = -20 °C, 96 Hrs
High Temperature Storage	T _S = 80 °C, 96 Hrs
Low Temperature Storage	T _S = -30 °C, 96 Hrs
High Temperature & Humidity Storage	T _S = 60 °C, 120 Hrs, 90% RH
Thermal Shock (Non-Operation)	-30 °C (30 min) ~ 80 °C (30 min) Change time: 5 min, 10 cycles
ESD (Operation)	C = 150 pF, R = 330 Ω, 5 points/panel Air: 8 KV (5x), Contact: 4 KV (5x)
Vibration (Non-Operation)	Frequency Range: 10 Hz ~ 55 Hz Stroke: 1.5 mm Sweep: 10 Hz ~ 55 Hz ~ 10 Hz 2 Hrs each in X, Y, Z directions
Package Drop Test	Height: 80 cm 1 corner, 3 edges, 6 surfaces

7.1 Inspection Criteria

INSPECTION ITEM	CRITERIA
Appearance	No cracks present on FPC No cracks present on LCD panel
LCD Panel Alignment	No bubbles present on/in LCD panel No alignment defects in active area
Electrical Current	Within device specifications
Function/Display	No broken circuits nor short circuits present No black lines present on LCD panel No other display defects

²¹ Functional test shall be conducted after 4 hours of storage at normal temperature and humidity, after LCD is removed from test chamber.

8 Precautions for Use of LCD Modules

8.1 Safety

Liquid crystal in LCD is poisonous. Do not put in mouth. If liquid crystal comes in contact with skin or clothes, wash it off immediately using soap and water.

8.2 Handling

- A. The LCD panel is made of plate glass. Do not subject the panel to mechanical shock or excessive force on its surface.
- B. In order to ensure reliability, do not hold product by flexible printed circuit (FPC) cable.
- C. Provide space so that panel does not come into contact with other components.
- D. To protect the product from external force, apply a covering lens (acrylic board or similar) and keep an appropriate gap between them.
- E. Transparent electrodes may be disconnected if the panel is used in an environment where dew condensation is present.
- F. Properties of semiconductor devices may be affected when exposed to light, possibly resulting in IC malfunctions. To prevent such malfunctions, design and mounting layout should be done in such a way that IC is not exposed to light in actual use.

8.3 Static electricity

- A. Ground soldering iron tips, tools and testers when they are in operation.
- B. Ground your body when handling the products.
- C. Power on the LCD module before applying the voltage to the input terminals.
- D. Do not apply voltage which exceeds the absolute maximum rating.
- E. Store the products in an anti-electrostatic bag or container.

8.4 Storage

- A. Store product in a dark place at $+25^{\circ}\text{C} \pm 10^{\circ}\text{C}$ with low humidity (40% RH ~ 60% RH). Do not expose the display to sunlight or fluorescent light.
- B. Storage in a clean environment, free from dust, active gas, and solvent.

8.5 Cleaning

- A. To clean the product, wipe with a soft cloth moistened with ethanol. Do not allow ethanol to get between upper film and bottom glass, as this may cause peeling issues and/or defective operation. Do not use any organic solvent or detergent other than ethanol.

8.6 Cautions for installation and assembly

- A. Bezel edge must be positioned between Active area and Viewing area.
- B. For a stable display assembly, Displaytech recommends designing a support for the backside of the display.
- C. Do not display any fixed pattern for long periods of time. If a fixed pattern must be displayed, use a screen saver in order to avoid image persistence.

9 Mechanical Drawings

9.1 DT043CTFT-IPS

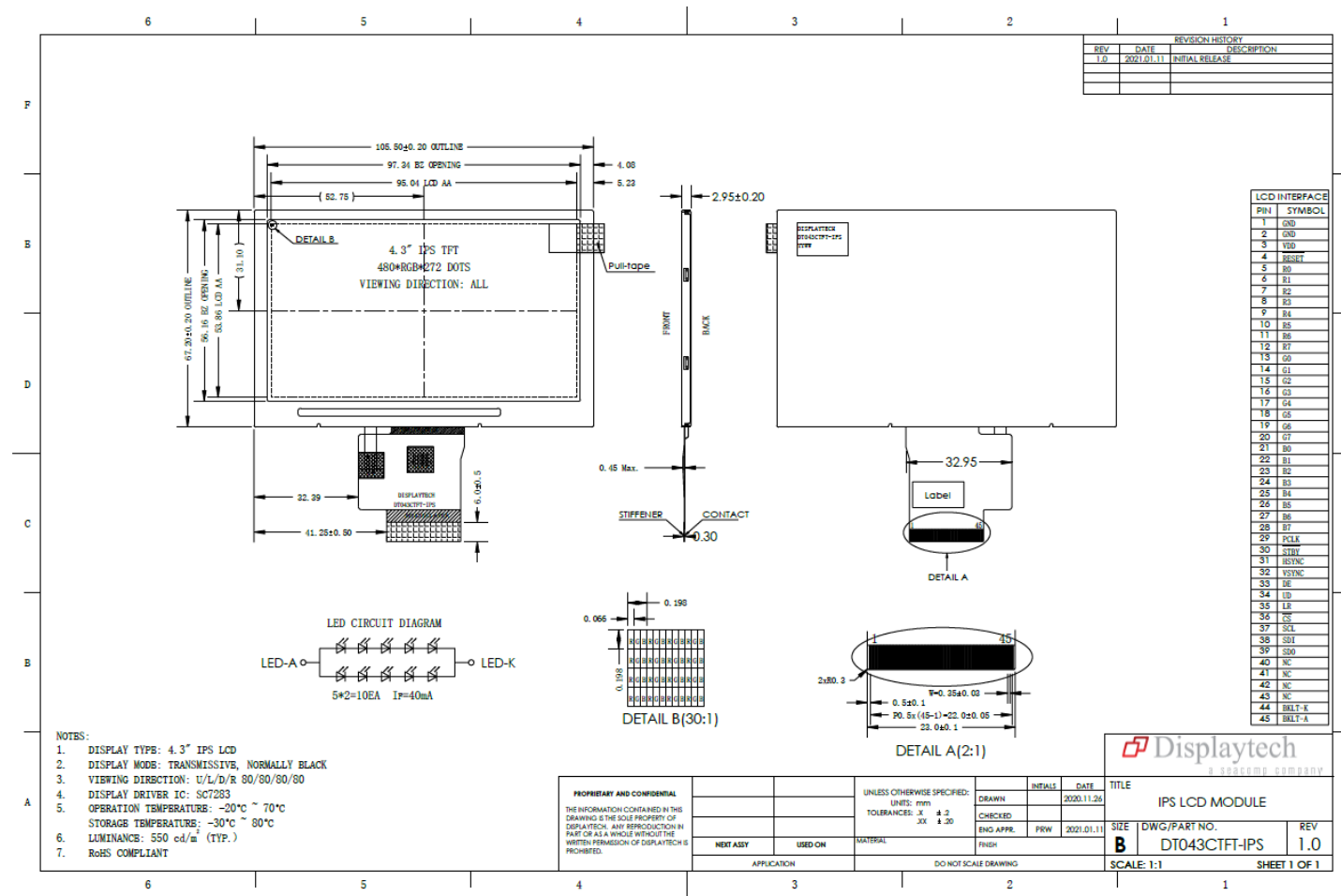

9.2 DT043CTFT-IPS-PTS

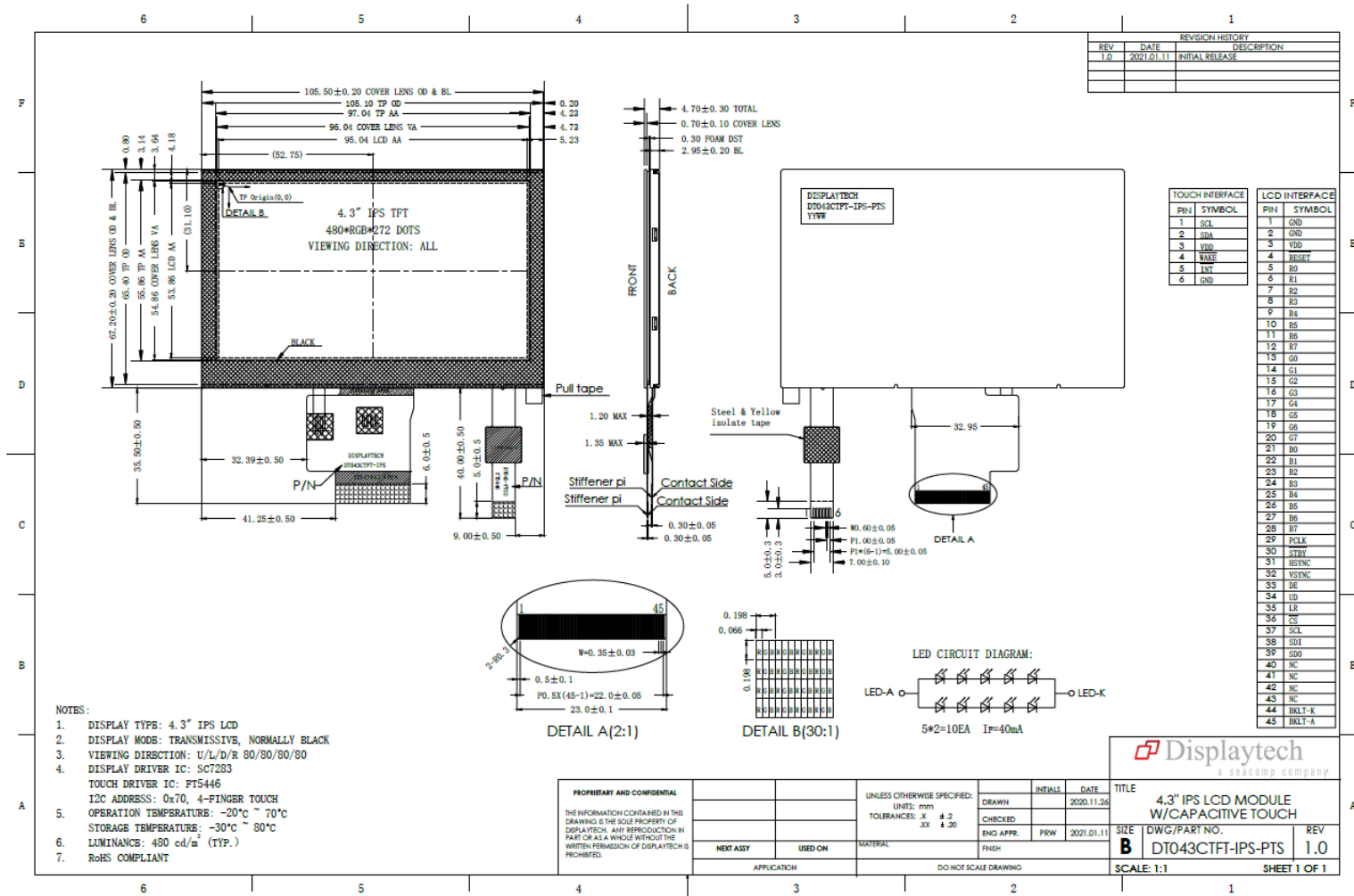

8.3 DT043CTFT-IPS-TS

